

# Three-Tab Shingles

# 10

**YOUR OBJECTIVE:**

*To learn the correct procedures for installing three-tab type strip shingles.*

**ENGLISH DIMENSIONS**

**XT™ 30, XT™ 30 IR, XT™ 25, CT 20,**

**METRIC DIMENSIONS**

**CT 20, XT 25, XT 30**

All of these shingles are “good” or “better” quality roofing products. This means that when offering a choice of “good,” “better” and “best” products, these shingles would fall in the “good” or “better” categories.

**All CertainTeed three-tab shingles are made to have a dimensional tolerance size of  $\pm 1/16$ ”.**

XT30 IR – the IR stands for impact resistant – is specially manufactured with a reinforced fiberglass scrim to meet UL 2218 Class 4 impact resistance rating and is also algae-resistant.

**NOTE:** XT30 IR must be installed over a clean deck (no roof-overs) to obtain the UL 2218 rating. It is strongly recommended that impact resistant cap shingles made from XT 30 IR shingles be installed on all hips and ridges. Some insurance carriers may not consider the roof system as compliant to UL 2218 Class 4 without impact resistant cap shingles

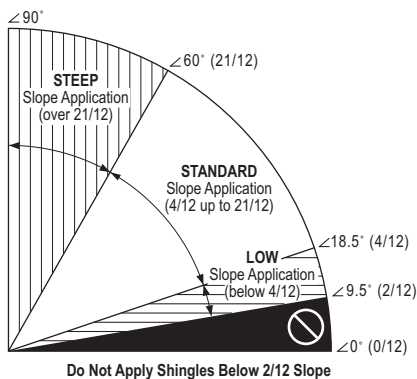

Figure 10-1: Slope definitions.

**STANDARD OR STEEP SLOPES:** CertainTeed recommends DiamondDeck™ Synthetic Underlayment, Roofers' Select™ High Performance Underlayment, or shingle underlayment meeting ASTM D226, D4869 or D6757. Take care to ensure sufficient deck ventilation when DiamondDeck or other synthetic underlayment is installed.

**LOW SLOPES:** One layer of CertainTeed's WinterGuard™ Waterproofing Shingle Underlayment (or equivalent, meeting ASTM D1970) or two layers of 36" wide felt shingle underlayment (Roofers' Select or underlayment product meeting ASTM D226, D4869 or D6757) lapped 19" must be applied over the entire roof; ensure sufficient deck ventilation. When DiamondDeck or other synthetic underlayment is installed, weather-lap at least 20" and ensure sufficient deck ventilation.

**THE ROOF DECK\* MUST BE AT LEAST:** 3/8" (9.5 mm) thick plywood, or 7/16" (11 mm) thick non-veneer, or nominal 1" (25 mm) thick wood deck.

**COLD WEATHER CLIMATES (ALL SLOPES):** Application of WinterGuard or its equivalent is strongly recommended whenever there is a possibility of ice build-up. Follow manufacturer's application instructions.

**FLASHING:** Corrosion-resistant flashing must be used to help prevent leaks where a roof meets a wall, another roof, a chimney or other objects that penetrate a roof.

**SEALING:** Shingle sealing may be delayed if shingles are applied in cool weather and may be further delayed by airborne dust accumulation. If any shingles have not sealed after a reasonable time period, hand sealing may be necessary.

**CAUTION:** To prevent cracking, shingles must be sufficiently warm to allow proper forming for hips, ridges and valleys.

**WARRANTY:** These shingles are warranted against manufacturing defects and are covered by SureStart™ protection. See the warranty itself for specific details and limitations.

**NOTE:** Some roofers choose to apply shingles at 4" exposure (vs. standard 5") at slopes less than 4/12 in order to increase the wind-driven rain resistance. In some cases, this can be an acceptable practice, but there are risks for which CertainTeed will not take responsibility. A shortened exposure can harm the appearance of the applied roofing, especially those with shadow lines, and it can reduce shingle ability to resist wind blow-offs by shifting the adhesive seal line away from the bottom edge of the shingles.

\*

## FASTENING

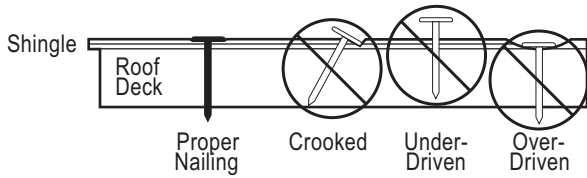

Figure 10-2: Proper and improper nailing.

**IMPORTANT:** For decks  $\frac{3}{4}$ " (19 mm) thick or thicker, nails must go at least  $\frac{3}{4}$ " (19 mm) into the deck. On thinner decks, nails must go at least  $\frac{1}{8}$ " (3.2 mm) through the deck.

Nails must be 11- or 12-gauge roofing nails, corrosion-resistant, with at least  $\frac{3}{8}$ " (9.5 mm) heads, and at least 1" (25 mm) long.

### LOW AND STANDARD SLOPE

#### ENGLISH

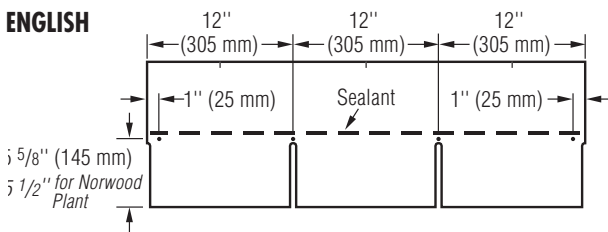

#### METRIC

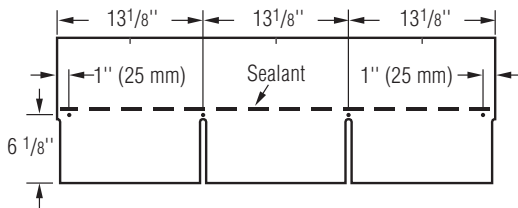
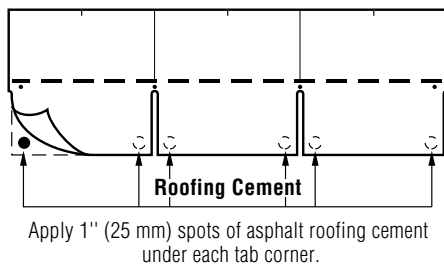

Figure 10-3: Use **four** nails for every full shingle.

### STEEP SLOPE

Use **four** nails and six spots of asphalt roofing cement\* for every full shingle (Figure 10-4). Asphalt roofing cement meeting ASTM D4586 Type II is suggested.



Apply 1" (25 mm) spots of asphalt roofing cement under each tab corner.

Figure 10-4: Use **four** nails and six spots of asphalt cement on steep slopes.

\***CAUTION:** Excessive use of roofing cement can cause shingles to blister.

### HIGH WIND AREAS

#### DO NOT USE STAPLES.

"Storm nailing" is not required by CertainTeed; however, the installer can use six nails to secure each shingle. In addition, the installer can seal each shingle with four spots of asphalt roofing cement ASTM D4586 Type II the size of a quarter, equally spaced, but it is not required by CertainTeed.

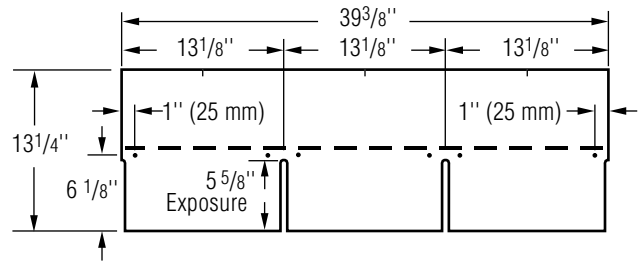

Figure 10-5: **Six** nails can be used for high wind applications.

## THREE CLEAN-DECK APPLICATION METHODS FOR ENGLISH DIMENSION SHINGLES

Install on new roofs and tear-offs using the following methods:

- ◆ The standard "Six-Course, Six-Inch, Stepped-Off Diagonal Method";
- ◆ The alternate "Five-Inch, Stepped-Off Diagonal Method"; or
- ◆ The alternate "Six-Inch, Single-Column, Vertical Racking Method."

### (1) SIX-COURSE, SIX-INCH, STEPPED-OFF DIAGONAL METHOD ("SIX UP, SIX OFF")

#### PREPARING THE DECK:

- ◆ Apply underlayment as required. CertainTeed suggests that a layer of shingle underlayment be applied. For UL fire rating, underlayment is generally required. Apply flat and unwrinkled.
- ◆ Snap horizontal and vertical chalklines to assure shingles will be correctly aligned. Expose all shingles 5" (125 mm).

#### STARTER COURSE:

1. Use CertainTeed Swiftstart™ or Universal Starter or a starter course consisting of the shingles from which the lower 5" tabs have been removed (Figure 10-6). Remember, the sealant on starter courses should lie as close as possible to the eaves edge of the roof.

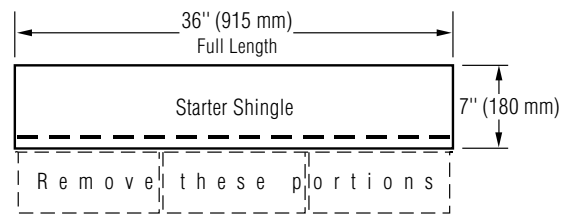

Figure 10-6: Make starter shingles by removing the lower 5" tabs.

2. Next, cut 6" off the length of the first starter-course shingle. Install this shingle on the lower left corner of the roof. Make sure there is  $\frac{1}{2}$ " left overhanging both rakes and eaves if drip edge is being used. If you are not using drip edge, make the overhang  $\frac{3}{4}$ ".
3. Continue with full-length starter course shingles along the eaves (Figure 10-7).

**1ST COURSE:** Apply a full shingle at the lower left corner of the roof. Make tabs lie flush with the edges of the starter course. In this way, sealant on the starter strip will adhere to the first-course tabs and help keep them from lifting in high winds (Figure 10-8).

## 2ND THROUGH 6TH COURSES:

1. Cut 6" off the left side of a shingle and install this 30" piece over and above the first-course shingle, in line with the left edge of the starter course. Leave the 5" tabs of the first-course shingle exposed (*Figure 10-8*).
2. Cut 12" off the first shingle of the third course, 18" off the first shingle of the fourth course, 24" off the first shingle on the fifth course, and 30" off the first shingle of the sixth course. Apply each with its left edge in line with the previous course (*Figure 10-8*).
3. Install full shingles flush against the six applied courses (*Figure 10-10* – see **A**).

**SUCCEEDING COURSES:** As you go up the rake, repeat the same pattern used to start the first six courses (*Figure 10-10* – see **B**).

Finish the courses with full shingles, working from the eaves up the roof.

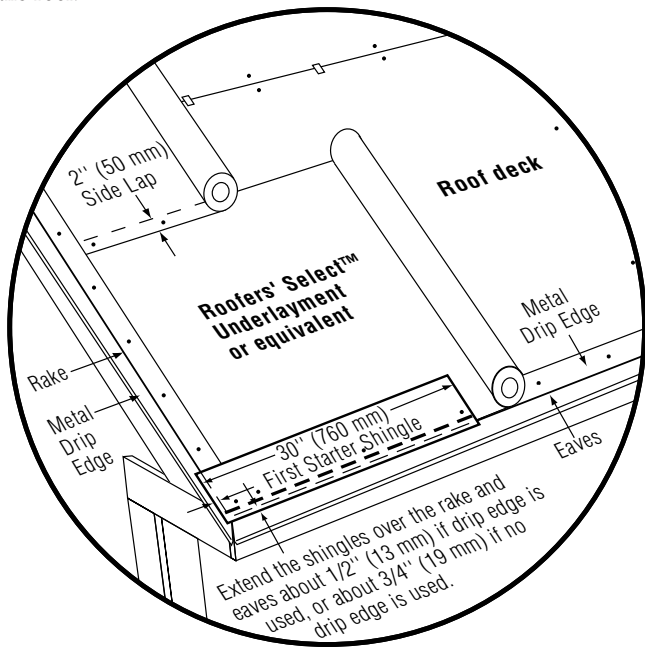

Figure 10-7: Standard slope underlayment and starter drip edge details.

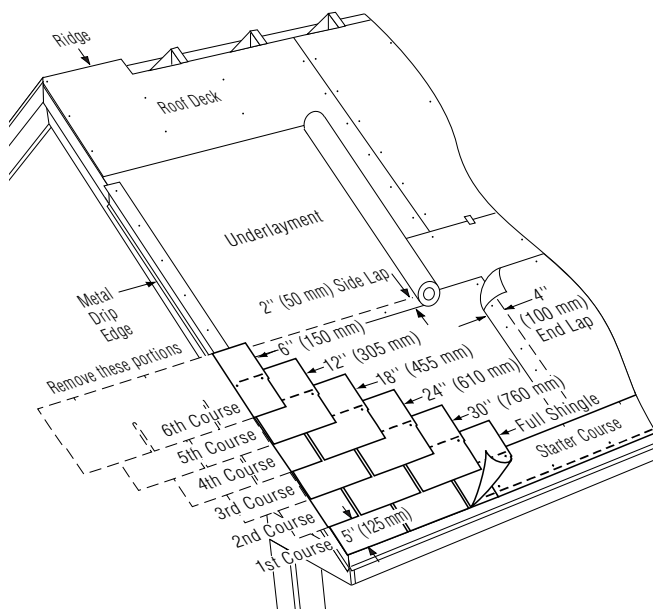

Figure 10-8: Applying the first 6 courses on a standard slope.

## (2) FIVE-INCH, STEPPED-OFF DIAGONAL METHOD ("TWELVE UP, FIVE OFF")

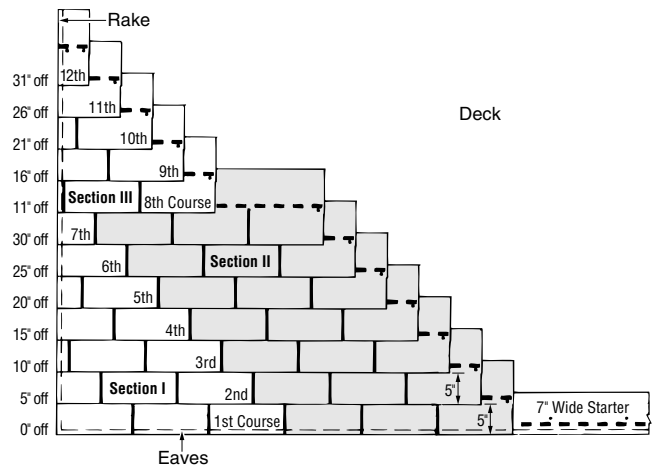

Figure 10-9: Five-Inch, Stepped-Off Diagonal Method.

### STARTER COURSE:

1. Use CertainTeed Swiftstart or Universal Starter or a starter course consisting of the shingles from which the lower 5" tabs have been removed (*Figure 10-6*). Remember, the sealant on starter courses should lay as close as possible to the eaves edge of the roof.
2. Cut 5" off the length of the first starter strip and apply the resulting 31" piece at the lower left corner of the roof. This starter strip should overhang the rakes and eaves  $\frac{1}{2}$ " when drip edge is used, or  $\frac{3}{4}$ " when no drip edge is used (*Figure 10-7*).
3. Continue with full-length starter-course shingles along the eaves.

**1ST COURSE:** Begin "Section I" by applying a full shingle at the lower left corner of the roof, tabs flush with the starter course.

### 2ND TO 7TH COURSE:

1. Begin the second course by cutting 5" off the left end of a shingle and applying the 31" piece over the first-course shingle, flush with the left edge of the first-course shingle, and exposing the first course 5" (*Figure 10-9*).
2. Each succeeding course, up to and including the seventh course, should start with a shingle 5" shorter (off the left end) than the previous course. Expose each course 5". This completes "Section I" and establishes the first seven courses of the 12-course repeating cycle.
3. Install "Section II" as shown in *Figure 10-9* using full shingles against the seven courses in "Section I." This must be done before continuing with courses eight through 12 ("Section III"). These "Section II" shingles are to be butted-up against the "Section I" shingles that started courses one through seven. Fasten all shingles in the normal fashion.

*Here's a Tip... Always try to use full shingles for the last shingles going into a closed valley. This will help avoid the problem of nailing too close to the centerline. (Thanks for this tip go to Dave Mulbolland of Ohio.)*

Figure 10-10: "Six Up, Six Off" installation schematic.

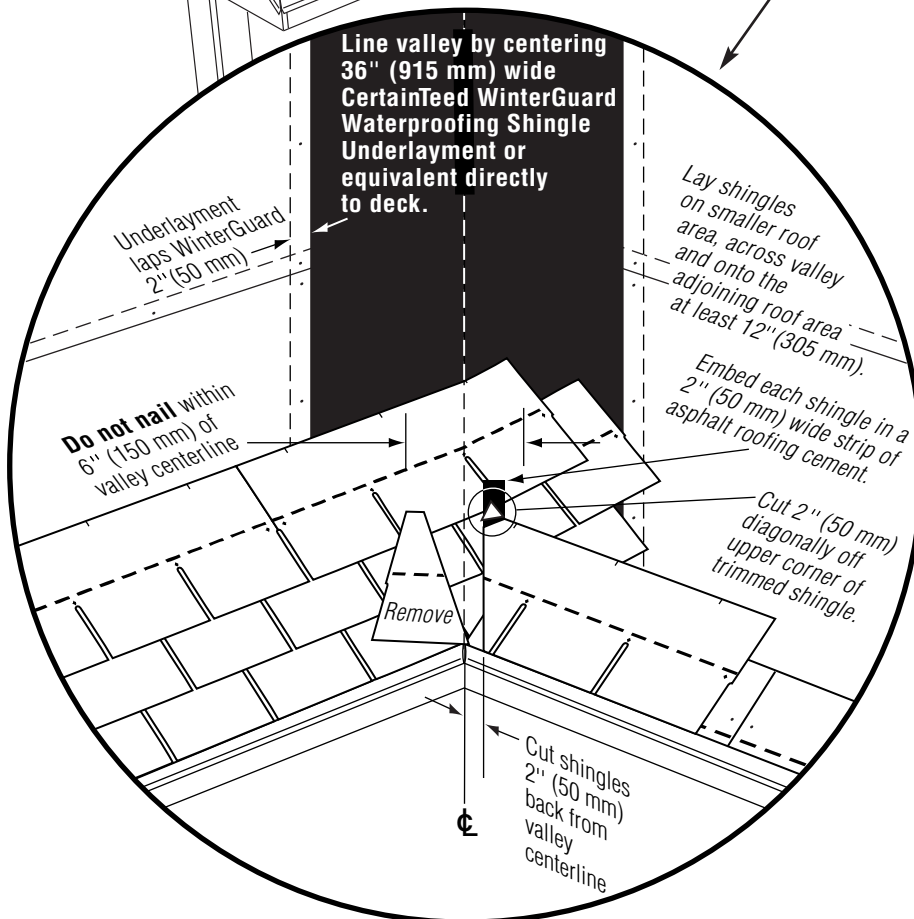
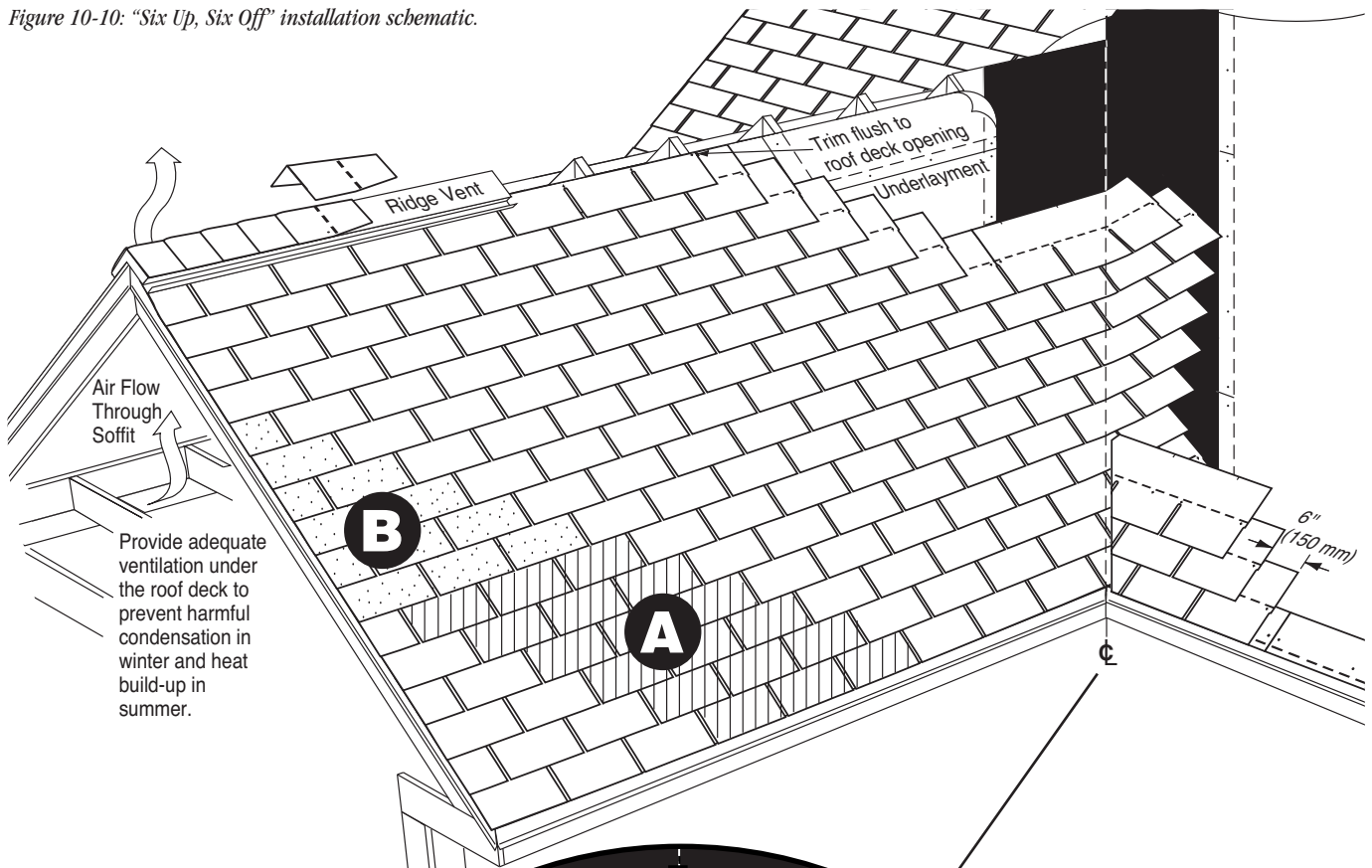

Figure 10-11: Highlight of closed-cut valley details.

*Here's a Tip...* Start racking installations in the middle of a roof plane. Snap (vertical) lines 6" apart for three-tab shingles. This minimizes keyways getting out of alignment in the middle of the roof, and cut-offs are the same on both rakes. (Thanks for this tip to Dave Daley of Alexandria, Virginia.)

#### 8TH THROUGH 12TH COURSES:

1. Begin the eighth course by cutting 11" off the left end of a shingle and applying the 25" piece over the seventh-course shingle, flush with the left edge of the seventh-course shingle, and exposing the seventh course 5" (Figure 10-9).
2. Start each succeeding course, up to and including the twelfth course, with a shingle 5" shorter (off the left end) than the previous course. Expose each course 5".
3. Installation of the pieces for courses eight through twelve completes "Section III" and establishes the final five courses of the two-part (twelve-course) pattern.
4. Continue working away from the twelve courses just applied by installing full shingles (not shown on the diagram).

#### SUCCEEDING COURSES:

1. Repeat the above two-part, twelve-course procedure, alternating the seven- and five-course sections up the roof. Start each subsequent seven-course section with a full shingle and start each five-course section with a 25" shingle (11" cut off the left end).
2. Complete courses across the roof using full shingles.

#### (3) SIX-INCH, SINGLE-COLUMN, VERTICAL RACKING METHOD ("RACKING")

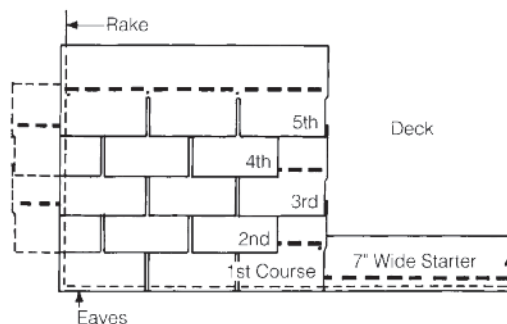

Figure 10-12: Vertical Racking Method.

#### STARTER COURSE:

1. Use CertainTeed Swiftstart or Universal Starter or a starter course consisting of the shingles from which the lower 5" tabs have been removed (Figure 10-6). Remember, the sealant on starter courses should lay as close as possible to the eaves edge of the roof.
2. Cut 6" off the length of the first starter strip and apply the 30" piece at the lower left corner of the roof. This starter strip should overhang the rakes and eaves  $\frac{1}{2}$ " when drip edge is used, or  $\frac{3}{4}$ " when no drip edge is used.
3. Continue with full-length starter-strip shingles along the eaves.

**1ST COURSE:** Apply a full shingle at the lower left corner of the roof, tabs flush with the starter course (Figure 10-12).

**2ND COURSE:** Cut 6" off the left end of a shingle and apply the 30" piece over the first-course shingle, flush with the left edge and exposing the first course 5" (Figure 10-12).

#### SUCCEEDING COURSES:

1. Begin the application of the remaining courses by alternating the use of full shingles and 30" (6" cut off the left end of a full shingle) shingles all the way up the rake in a single column. Expose each course 5".
2. Fasten the full shingles with three fasteners, leaving the right-hand tab edge unfastened until later.
3. Fasten the 30" pieces of shingle using four fasteners.
4. This method will establish the Six-Inch Offset Vertical Racking pattern.

#### COMPLETING THE INSTALLATION:

1. Full shingles are to be butted against the right side of applied shingles in each course. Work up the roof from the eaves, one vertical column at a time, maintaining the 5" exposure.
2. In the courses where the right-hand shingle tab in the course above was purposely left unfastened, carefully lift the loose shingle tab so as not to cause damage by tearing or sharply bending, especially at the top of the cutout tab "keyway," and slip the next shingle underneath to butt the hidden shingle edge.
3. Apply all four fasteners to the newly placed shingle and one fastener to the free end of the shingle tab above it.
4. In alternate courses where new shingles butt against the visible shingle tabs, initially apply only three fasteners, leaving the right edge free.
5. Repeat this procedure (applying one vertical column at a time) to complete courses across the roof.

#### CAUTION:

1. This "single column" method is approved for applying some types of CertainTeed shingles. However, "double column" vertical racking (in which two shingles are laid side by side up the roof) is **NOT** recommended because it can result in unattractive patterns.
2. It is very important to fasten the ends of shingles properly. Nailing high or leaving nails out can result in an unattractive rack-line pattern.

*Here's a Tip...* Use all the shingles from one bundle before using shingles from another bundle. This will result in the most pleasing color blends on the finished roof.

## THREE CLEAN-DECK APPLICATION METHODS FOR METRIC SHINGLES

Install on new roofs and tear-offs using the following methods:

- ◆ The Seven-Course, 5<sup>5</sup>/<sub>8</sub>" Stepped-Off Diagonal Method ("Random 5<sup>5</sup>/<sub>8</sub>" Method");
- ◆ The alternate "Eight-Course, Five-Inch, Stepped-Off Diagonal Method"; or
- ◆ The alternate "Half-Tab Method."

### SEVEN-COURSE, 5<sup>5</sup>/<sub>8</sub>" STEPPED-OFF DIAGONAL METHOD (RANDOM 5<sup>5</sup>/<sub>8</sub>" METHOD)

#### PREPARING THE DECK:

- ◆ Apply underlayment as required. CertainTeed suggests that a layer of shingle underlayment be applied. For UL fire rating, underlayment is generally required. Apply flat and unwrinkled.
- ◆ Snap horizontal and vertical chalk lines to assure shingles will be correctly aligned. Expose all shingles 5<sup>5</sup>/<sub>8</sub>" (141 mm).

#### STARTER COURSE:

1. Use CertainTeed Swiftstart or a starter course consisting of the shingles from which the lower tabs have been removed (*Figure 10-13*). Remember, the sealant on starter courses should lay as close as possible to the eaves edge of the roof.

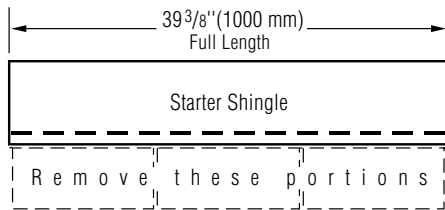

Figure 10-13: Make starter shingles by removing the lower tabs.

2. Next, cut half of a tab off the length of the first starter-course shingle. Install this shingle on the lower left corner of the roof. Make sure there is <sup>1</sup>/<sub>2</sub>" left overhanging both rakes and eaves if drip edge is being used. If you are not using drip edge, make the overhang <sup>3</sup>/<sub>4</sub>".
3. Continue with full-length starter-course shingles along the eaves. (*Figure 10-13*).

**1ST COURSE:** Apply a full shingle at the lower left corner of the roof. Make tabs lie flush with the edges of the starter course. In this way, sealant on the starter strip will adhere to the first-course tabs and help keep them from lifting in high winds (*Figure 10-14*).

#### 2ND THROUGH 7TH COURSES:

1. Cut 5<sup>5</sup>/<sub>8</sub>" off the left side of a shingle and install this 33<sup>3</sup>/<sub>4</sub>" piece over and above the first-course shingle, in line with the left edge of the starter course (*Figure 10-14*).
2. Cut 11<sup>1</sup>/<sub>4</sub>" off the first shingle of the third course, 16<sup>7</sup>/<sub>8</sub>" off the first shingle of the fourth course, 22<sup>1</sup>/<sub>2</sub>" off the first shingle on the fifth course, 28<sup>1</sup>/<sub>8</sub>" off the first shingle of the sixth course, and 33<sup>3</sup>/<sub>4</sub>" off the first shingle of the seventh course. Apply each with its left edge in line with the previous course (*Figure 10-14*).
3. Install full shingles flush against the seven applied courses.

**SUCCEEDING COURSES:** As you go up the rake, repeat the same pattern used to start the first seven courses. Finish the courses with full shingles, working from the eaves up the roof.

**IMPORTANT:** Do not align end joints of a given course closer than 5<sup>5</sup>/<sub>8</sub>" from one another, and they must be at least 3" from the nails on the underlying course.

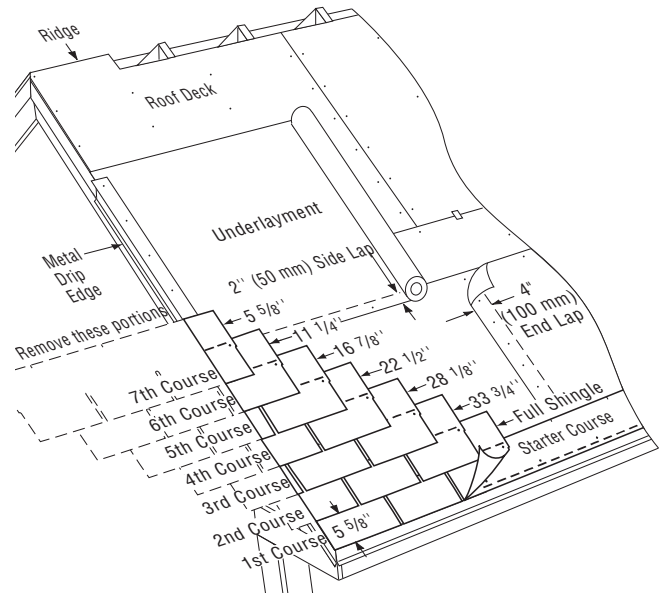

Figure 10-14: Applying the first 7 courses on a standard slope.

### EIGHT-COURSE, FIVE-INCH, STEPPED-OFF DIAGONAL METHOD

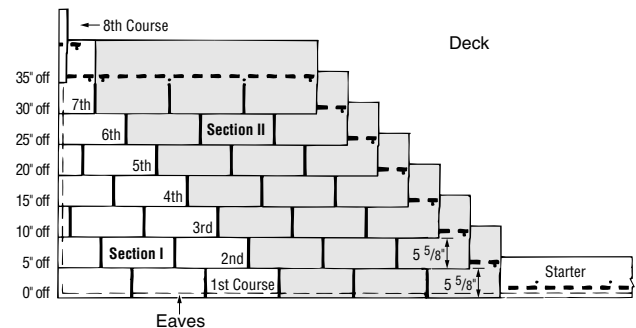

Figure 10-15: Eight-Course, Five-Inch, Stepped-Off Diagonal Method.

#### STARTER COURSE:

1. Use CertainTeed Swiftstart or a starter course consisting of the shingles from which the lower tabs have been removed (*Figure 10-13*). Remember, the sealant on starter courses should lay as close as possible to the eaves edge of the roof.
2. Cut 3" off the length of the first starter strip and apply at the lower left corner of the roof. This starter strip should overhang the rakes and eaves <sup>1</sup>/<sub>2</sub>" when drip edge is used, or <sup>3</sup>/<sub>4</sub>" when no drip edge is used.
3. Continue with full-length starter-course shingles along the eaves. (*Figure 10-15*).

**1ST COURSE:** Begin "Section I" by applying a full shingle at the lower left corner of the roof, tabs flush with the starter course.

#### 2ND TO 8TH COURSE:

1. Begin the second course by cutting 5" off the left end of a shingle and applying the 34<sup>3</sup>/<sub>8</sub>" piece over the first-course shingle, flush with the left edge of the first-course shingle, and exposing the first course 5<sup>5</sup>/<sub>8</sub>" (*Figure 10-15*).

- Each succeeding course, up to and including the eighth course, should start with a shingle 5" shorter (off the left end) than the previous course. Expose each course 5<sup>5</sup>/<sub>8</sub>". This completes "Section I".
- Install "Section II" as shown in *Figure 10-15* using full shingles against the eighth courses in "Section I." This must be done before continuing with course nine. These "Section II" shingles are to be butted-up against the "Section I" shingles.

**SUCCEEDING COURSES:**

- Repeat the above two-part procedure up the roof.
- Complete courses across the roof using full shingles.

**HALF-TAB METHOD**

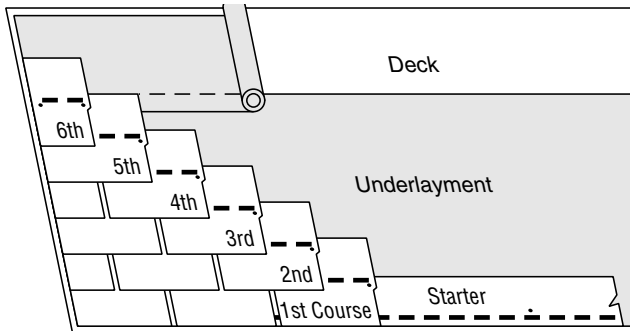

*Figure 10-16: Half-Tab Method.*

**STARTER COURSE:**

- Use CertainTeed Swiftstart or a starter course consisting of the shingles from which the lower tabs have been removed (*Figure 10-13*). Remember, the sealant on starter courses should lay as close as possible to the eaves edge of the roof.
- Cut half a tab off the length of the first starter strip and apply at the lower left corner of the roof. This starter strip should overhang the rakes and eaves 1/2" when drip edge is used, or 3/4" when no drip edge is used.
- Continue with full-length starter-strip shingles along the eaves. (*Figure 10-16*).

**1ST COURSE:** Apply a full shingle at the lower left corner of the roof, tabs flush with the starter course (*Figure 10-16*).

**2ND COURSE:** Cut 6<sup>9</sup>/<sub>16</sub>" (half of a tab) off the left end of a shingle and apply the remaining piece over the first-course shingle, flush with the left edge and exposing the first course 5<sup>5</sup>/<sub>8</sub>" (*Figure 10-16*).

**3RD THROUGH 6TH COURSES:** Each succeeding course, up to and including the sixth course, should start with a shingle one-half of a tab (6<sup>9</sup>/<sub>16</sub>" ) shorter (cut-off from the left end) than the previous course (*Figure 10-16*). Expose each course 5<sup>5</sup>/<sub>8</sub>".

**NOTE:** Most CertainTeed 3-tab shingles have 3 aligning notches cut into the headlap which can be used as a guide to line-up the cut-outs.

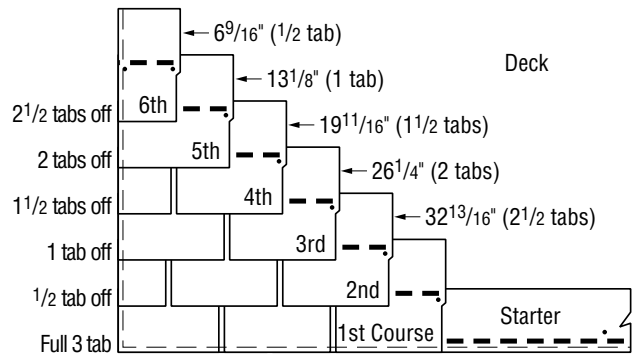

*Figure 10-17: Half-Tab Method.*

**CHIMNEY FLASHING**

**Metal Step Flashing**

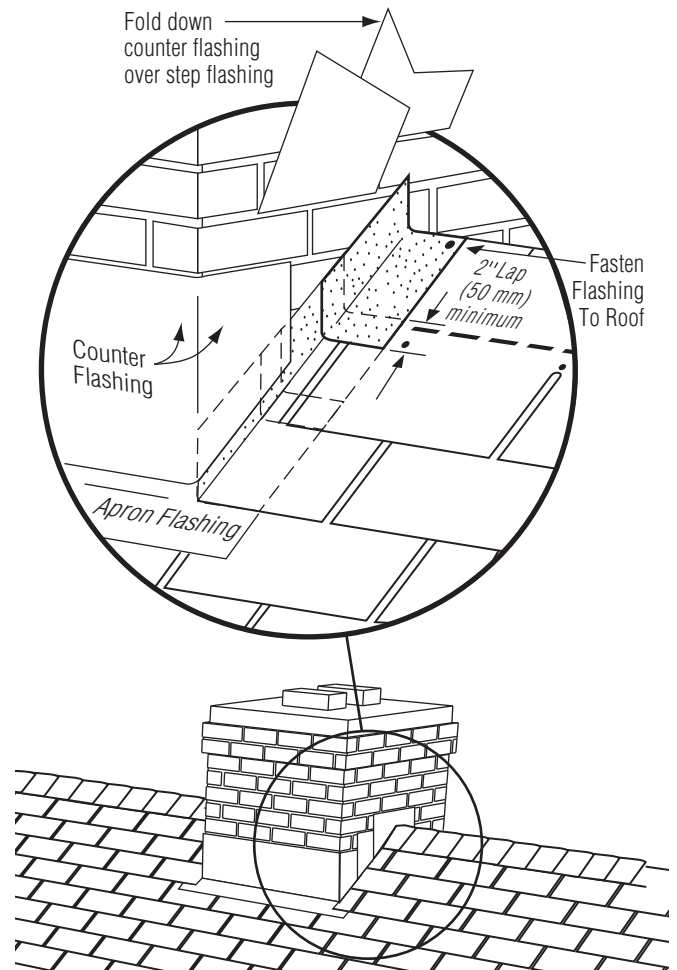
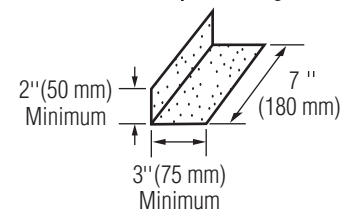

*Figure 10-18: Flashing around a chimney.*

*Here's a Tip...* Stack all the pieces of shingles that you trimmed to step the shingles up the roof. Use these pieces to fill in at the rakes or valley at the other end of the course. Never use pieces shorter than 4" at the rakes or 18" in the valley.

## THREE ROOF-OVER METHODS FOR ENGLISH DIMENSION SHINGLES

Reroofing over existing square-tab asphalt strip shingles with 5" tabs using the following methods:

- ◆ The standard approach of "nesting," sometimes called "butt and run," combined with the "Six-Course, Six-Inch, Stepped-Off Diagonal Method"; or
- ◆ The alternate approach of "nesting," combined with the "Five-Inch, Stepped-Off Diagonal Method"; or
- ◆ The alternate approach of "nesting," combined with the "Six-Inch, Single-Column Vertical Racking Method."

**NOTE:** Nesting is preferred over "bridging" methods when reroofing because nesting sheds water best and looks better. Nesting, as described below, is an easy application process over square-tab asphalt strip shingles with a 5" exposure. If you are covering a different type or size shingle, you may need to cut back the tabs so that nesting is possible. To do this, simply cut off the leading edge of all the **old shingle tabs** if they would be lapped less than 2 1/2" by the new shingles. This permits a flat nested application that avoids lifted edges and slumps.

### PREPARING THE ROOF SURFACE FOR REROOFING

- ◆ Make the surface of the old roof as smooth as possible by replacing missing shingles. Split and nail flat all buckled, raised tabs and curling shingles.

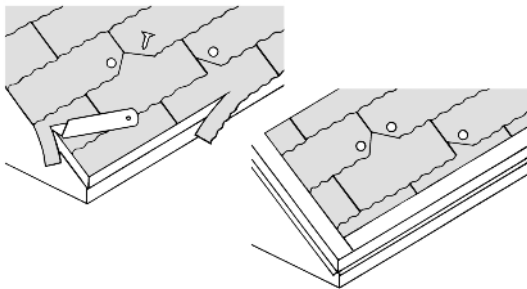

Figure 10-19: Preparing an old roof for reroofing.

- ◆ It's a good idea to cut old shingles back flush to the rakes and eaves.
- ◆ We suggest that you apply corrosion-resistant drip edge along the rakes and eaves, covering the edges of the old shingles. This will provide a uniform and straight edge that will help prevent water seepage under the shingle edges.

**SPECIAL NOTE:** The instructions that follow assume that the roof surface is dry and has been properly cleaned and prepared before reroofing.

### NESTING METHOD COMBINED WITH THE SIX-COURSE, SIX-INCH, DIAGONAL METHOD ("SIX OFF, SIX UP")

Cut old shingles back flush to rakes and eaves. Apply drip edge along rakes and eaves if recommended.

The Six-Course, Six-Inch, Stepped-Off Diagonal Nesting method of application described below is suggested for roofing over square-tab asphalt roofing shingles of 5" ± 1/8" (125 mm ± 3.2 mm) exposure.

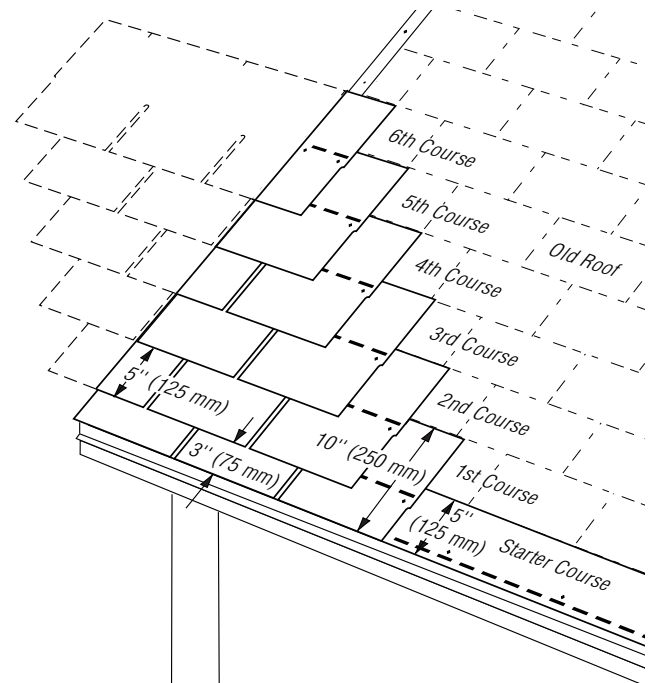

Figure 10-20: Six Off, Six Up, Nested.

#### STARTER COURSE:

1. Use 5" by 36" shingles for the starter course. To make a starter shingle, first cut the tabs off of a standard three-tab shingle, then cut off a strip 2" across the top of the same shingle.
2. Cut 6" off either side of the first starter shingle and install it over the first course of the old shingles, at the lower left corner (Figure 10-20).
3. Remember, the sealant on this starter course must lie as close as possible to the eaves edge of the roof. This will help hold the first-course shingles down and provide good protection against wind blow-offs, which could start at the roof edge.
4. If you are using drip edge, let the starter shingle extend out over the edge of the rake and eaves by 1/2". If you are not using drip edge, let the starter shingle extend over the rake and eaves by 3/4".
5. Finish the course using similarly prepared starter strips.

#### 1ST COURSE:

1. The first course is made of 10" by 36" shingle strips made by cutting 2" off the bottom of the tabs of regular shingles (Figure 10-20).
2. Align the top edge of the strips so they butt up (nest) against the tabs of the shingles in the old third course. Make the left edge align with the starter course.



### 2ND COURSE:

1. Cut 6" off the left end of a full shingle. Butt the top edge of this 12" by 30" piece of shingle up against the bottom edge of the shingle in the old fourth course. Make the left edge align with the first-course left edge (Figure 10-20).
2. Exposure of the first course (only) is 3". All succeeding course exposures will duplicate exposures of the existing roof (approximately 5").

### 3RD AND SUCCEEDING COURSES:

1. For the third course, cut 12" off the left side of a full shingle (a whole tab).
2. Apply this 24" piece of shingle over the second course, leaving the 5" tabs of the second course exposed. The top edge of the new shingle in this course should butt up against the bottom of the fifth course of old shingles (Figure 10-20).
3. Cut an additional 6" off the first shingle of each higher course until you have to start with a full shingle again on the seventh course. In other words, cut 18" off the first shingle of course four, 24" off the first shingle in course five, 30" off the first shingle in course six. On course seven, start over with a full 36" shingle.
4. Install full shingles against the six applied courses.

### REMAINING COURSES:

1. As you go up the rake, repeat the pattern used to start courses one through six.
2. Finish the courses with full shingles, working from the eaves up the roof.

### COMBINING THE "NESTING METHOD" WITH THE ALTERNATE 12-COURSE, FIVE-INCH, STEPPED-OFF DIAGONAL METHOD ("FIVE OFF, TWELVE UP")

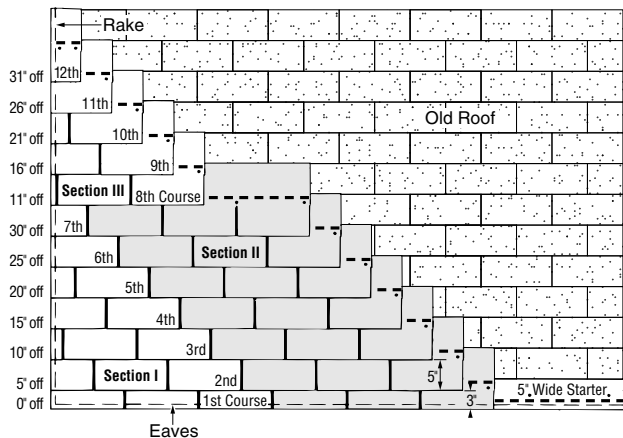

Figure 10-21: Five Off, Twelve Up, Nested.

### STARTER COURSE:

1. Use 5" by 36" shingles for the starter course. To make a starter shingle, first cut the tabs off of a standard three-tab shingle, then cut off a strip 2" across the top of the same shingle.
2. Cut 5" off the length of the first starter strip, and align the 31" piece over the first course at the lower left corner of the existing roof.
3. This starter strip should overhang the rakes and eaves 1/2" when drip edge is used, or 3/4" when no drip edge is used.
4. Continue with full lengths of starter strips along the eaves.

**1ST COURSE:** The first course is made of 10" by 36" shingle strips made by cutting 2" off the bottom of the tabs of regular shingles. Align the top edge of the strips so they butt up against the tabs of the shingles in the old third course (Figure 10-21).

### 2ND THROUGH 7TH COURSES:

1. Begin the second course by cutting 5" off the left end of a shingle and aligning the top edge with the butt edge of the shingle in the old fourth course (Figure 10-21).
2. Exposure of the first course (only) is 3". All succeeding course exposures will duplicate the exposure of the existing roof (approximately 5").
3. Start each succeeding course, up to and including the seventh course, with a shingle 5" shorter (off the left end) than the first shingle of the previous course.
4. Align the top edges with butts of old shingles.
5. This completes "Section I" – the first seven courses of the 12-course repeating cycle.
6. Install full shingles against these seven courses.

### 8TH THROUGH 12TH COURSES:

1. Begin the eighth course by cutting 11" off the left end of a shingle and applying the 25" piece over the seventh course shingle, aligned with the left edge of the seventh course (Figure 10-21).
2. Each succeeding course, up to and including the twelfth course, starts with a shingle 5" shorter (off the left end) than the previous course.
3. Align all top edges with butts of old shingles. Exposure of each course will duplicate the exposure of the existing roof.
4. Install full shingles against all 12 courses.

**SUCCEEDING COURSES:** Going up the rake, repeat the 12-course pattern, alternating Sections "I" and "III" up the roof. Complete courses across the roof using full shingles working from the eaves up the roof.

### COMBINING THE "NESTING METHOD" WITH THE ALTERNATE SIX-INCH, SINGLE-COLUMN, VERTICAL RACKING METHOD ("RACKING")

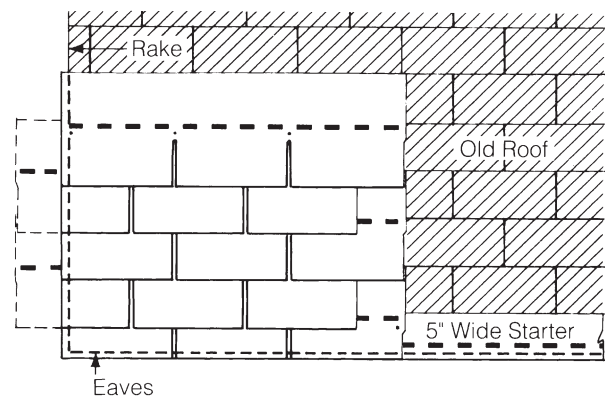

Figure 10-22: Vertical Racking, Nested.

### STARTER COURSE:

1. Use 5" by 36" shingles for the starter course, made by first cutting the tabs off of a standard three-tab shingle, then cutting off a strip 2" across the top of the same shingle.

*Here's a Tip...* Save the tabs that you cut off starter shingles for use as a vertical front wall base flashing cover. (Thanks for this tip go to both Darren L. Burke of Montclair, New Jersey, and Dave Mulbolland of Ohio.)

- Cut 6" off one side of the first starter shingle and install the 30" piece over the first course of the old shingles, at the lower left corner. This, and all other shingles, must nest with the butt edges of the old shingles (Figure 10-22).
- Remember, the sealant on this starter course must lay as close as possible to the eaves edge of the roof. This will help hold the first-course shingles down and provide good protection against wind blow-offs, which could start at the roof edge.
- If you are using drip edge, let the starter shingle extend out over the edge of the rake and eaves by  $\frac{1}{2}$ ". If you are not using drip edge, let the starter shingle extend over the rake and eaves by  $\frac{3}{4}$ ".
- Finish the starter course along the eaves using the prepared starter strips.

#### 1ST COURSE:

- The first course is made of 10" by 36" strips made by cutting 2" off the bottom of the tabs of regular shingles.
- Align the top edge of the 10" strips so they butt up (nest) against the tabs of the shingles in the old third course (Figure 10-22).

#### 2ND COURSE:

- Cut 6" off the left end of a full shingle. Nest the top edge of this new 12" by 30" piece of shingle up against the bottom edge of the shingles in the old fourth course (Figure 10-22).
- Exposure of the first course (only) is 3". All succeeding course exposures will duplicate exposures of the existing roof (approximately 5").

#### 3RD AND SUCCEEDING COURSES:

- Begin the application of succeeding courses by alternating the use of full shingles and 30" shingles (6" off the left end) up the rake in a single column (Figure 10-22).
- Fasten the full shingles with three fasteners, leaving the right-hand tab edge unfastened until later.
- Fasten the 30" pieces of shingle using four fasteners.
- Align all top edges with butts of old shingles.

#### COMPLETING THE INSTALLATION:

- Work up the roof from the eaves one vertical column at a time. Butt full shingles against the right-hand side of applied shingles in each course, maintaining the 5" exposure.
- In courses where the right-hand shingle tab in the course above was purposely left unfastened, carefully lift the loose shingle tab so as not to cause damage by tearing or sharply bending, and slip the next shingle underneath to butt the hidden shingle edge. Apply all four fasteners to the newly placed shingle and one fastener to the free end of the shingle tab above it.
- In alternate courses where the new shingles butt against the visible shingle tabs, initially apply only three fasteners, leaving the right-hand edge free.
- Repeat this procedure to complete columns and courses across the roof.

## INSTALLING ENGLISH OVER METRIC

Metric shingles are bigger by about 20 percent than standard size shingles. In inches, they measure  $13\frac{1}{4}$ " by  $39\frac{3}{8}$ ". The main **advantage** of metric shingles compared to standard shingles is the possibility of covering a little more of the roof in a little less time. The main **disadvantage** for reroofing is that the nesting method for covering the common 12" by 36" shingles uses more material because it does not take advantage of the full metric tab exposure.

The installation of an English-dimension shingle over a metric shingle is a little more labor-intensive than the typical English-over-English reroofing job, but it's not a very difficult process.

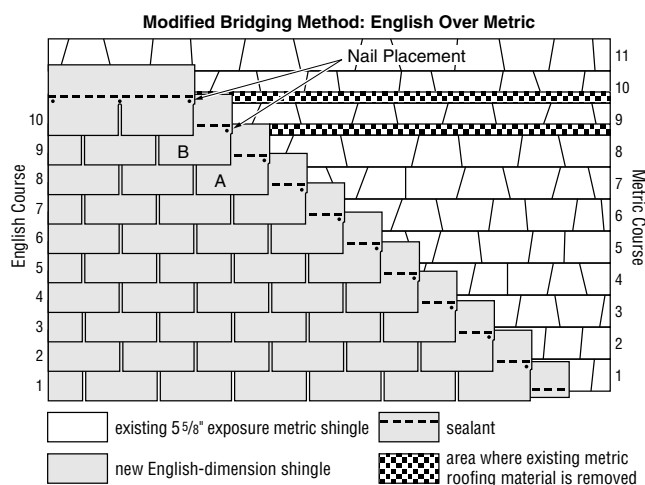

Figure 10-23: Reroofing using standard 12" x 36" shingles over metric shingles.

A standard metric shingle is typically exposed  $5\frac{5}{8}$ " to the weather. The illustration (Figure 10-23) shows an idealized method used to reroof with a 12" by 36" English-dimension shingle.

If the existing shingles have been cut back to the eaves, a  $5\frac{5}{8}$ " starter course is suggested. This enables the tabs of the first-course shingles to be sealed, and also helps reduce unevenness. A starter course is also helpful because the headlap of the first-course English shingle will likely butt against the bottom edge of the third course of the existing metric laminate. This provides a  $\frac{3}{4}$ " overhang at the eaves.

Apply succeeding courses (Nos. 2-8) with 5" exposures to the weather, as is typical in English-dimension shingle installation. Notice that each course gradually drops farther away from the leading edge of the shingle above. The English-dimension shingle can bridge that gap.

But when you reach the metric shingle's ninth course (the English shingle's eighth), the gap should not be bridged because the correct nail placement would be below the leading edge of the metric shingle underneath. Nailing in this area would draw down and warp the shingle on top, causing a hump.

To eliminate the problem, you must cut and remove, at the metric shingle's eighth course, approximately 2" of the leading edge of the next metric shingle up the roof, so that the English-dimension shingle nests smoothly. Do the same for the metric shingle's ninth course; the 10th course may naturally meet the butt edge of the shingle above

(Figure 10-23). Repeat this method on every eighth and ninth metric course up the roof. Counting from the first metric course, this means the 17th and 18th courses would also be cut back, as would the 25th and 26th, and so on.

**NOTE:** On an actual roof the course exposures will vary, so the directions above may need to be modified. An important **rule of thumb** is this: Each time the top edge of the English shingle overlaps the bottom edge of a metric shingle course by less than 1½", as shown by shingles "A" and "B" in Figure 10-23, cut that metric shingle back by 2" (or to fit) to allow the top edge of the English shingle to nest smoothly below it.

## TIPS FOR ROOFING OVER SMOOTH-OR DIMENSIONAL-BASE METRIC SHINGLES

In an English-over-metric roof-over, there are two different cases to consider: the smooth-surface base shingle and the dimensional-base shingle.

In both cases the common problem is the presence of gaps created between the new roof surface to be installed and the existing roof surface. The gaps occur as a function of the shingles being different sizes; they don't line up or "nest" exactly as they would in an English-to-English or metric-to-metric roof-over. Bridging the gaps over a thick, dimensional shingle is even more difficult than doing so over a smooth-surface shingle because of the uneven dimensional surface.

### SOLVING BRIDGING PROBLEMS: TWO RULES TO REMEMBER

**1. IN BRIDGING A GAP, A STIFFER SHINGLE ON TOP IS ALWAYS BETTER THAN A SOFTER SHINGLE:** Shingle stiffness depends on the type of shingle. For example, fiber glass three-tab shingles with a longer warranty duration are usually stiffer than those with a shorter duration.

The stiffest shingles, are the heavyweight and super-heavyweight premium shingles.

**2. CHOOSE A DESIGN THAT MASKS UNEVENNESS:** An uneven shingle surface will tend to visually intrude through the shingle surface above it, creating small humps in the new roof. So when you choose a shingle for a roof-over, it is best to choose one with a design that masks or disguises the uneven surface below. CertainTeed's Independence Shingle® with its deep shadow lines and textured look, makes an excellent choice.

If you're installing over a smooth-surface metric strip shingle, Classic Horizon Shingle® is an excellent choice. If you're installing over a dimensional shingle, Independence might be your best choice.

## ROOF-OVER METHODS FOR METRIC DIMENSION SHINGLES

The same methods used for clean-deck application of metric dimension shingles are used for roof-overs. Application of metric dimension shingles **over** English dimension shingles is not recommended — due to the high cost of workmanship and greater risk of worker error.

## HIPS AND RIDGES

1. First, apply the shingles up to the hip or ridge on both sides, then trim flush.
2. Make the caps by cutting full-length shingles at the tab cutouts. Trim the back end of the caps as shown in Figure 10-24.

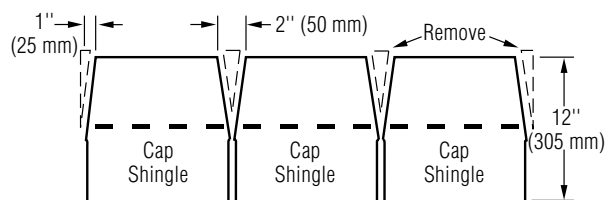

Figure 10-24: Cut tabs, then trim back to make cap shingles (English dimensions shown).

3. Start installing the caps at the bottom of a hip or at either end of a ridge.

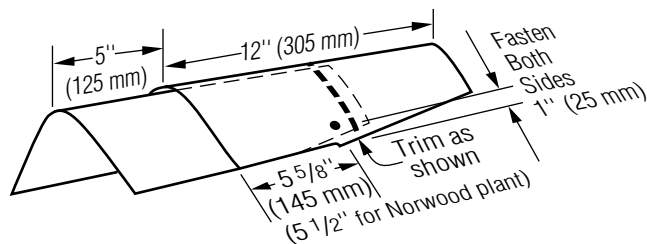

Figure 10-25: Installation of caps along the hips and ridges.

4. To prevent cracking, make sure the caps are warm enough to permit proper forming over the ridge or hip.
5. Fasten each cap shingle with two nails installed at 5⅝" (5½" for Norwood plant) from the bottom edge and 1" in from each side.
6. Leave only the 5" tab exposed to the weather. Do not expose fasteners.
7. You can improve the appearance of the roof by applying two layers. The thick double cap creates a richer-looking roof. However, be sure double caps have been estimated into the job price before you install them.
8. To add more definition and visual appeal to the rooflines, use CertainTeed's ShadowRidge™ or one of CertainTeed's enhanced profile hip and ridge caps.